



Ignite - Wired rev 2.0

www.inspirehomeautomation.co.uk



CAUTION: High Voltage Wires

WARNING Electricity is dangerous. Before commencing work, ensure that you read and understand these instructions and isolate the relevant circuit. **This product should only be installed by a qualified electrician or heating engineer** and should be installed in accordance to BS 7671 (IEE Wiring Regulations), or to another equivalent standard.

WHAT'S IN THE BOX

- 1 x Assembled Room Thermostat consisting of
 - 1 x Room Thermostat
 - 1 x Wall Mount
 - 1 x Wall Blanking Plate
- 1 x Screw Pack

INTRODUCTION

The Ignite wired Thermostat is designed to replace a wired Thermostat or ideal for refurbishments / new builds where a cable can be run.

Please ensure your existing Thermostat has at least a 3 core cable.

If you do not have an existing wired Thermostat, you would need to run a cable, or consider using our Ignite Wireless series. Once installed, your central heating can be switched on and off in response to commands from the Thermostat or remotely using a computer or Smart Phone.

SPECIFICATION

Power Supply: 230V~ 50...60Hz

Output: Volt-Free or 230V

Switch Type: 1 x SPST

Switch Rating: 3 Amps

Controllable Temperature Range: 0.5 – 30°C

Frost Protection: Programmable from 0.5 - 30°C

Radio Frequency: 2.4 GHz WiFi & 868 MHz

Dimensions: 103 x 103 x 45 mm (max)

RADIO SIGNAL

The Thermostat uses WiFi, so you need a WiFi signal where the Thermostat is located.

You can use your phone to get a good indication of signal strength, hold this against the wall where the Thermostat is located.

If you cannot get a good signal, consider using a WiFi Range extender to help boost the signal around the property.

The optional Smart Sensors connect via an internal low power radio..

BAD POSITIONING

The below image shows the path that the signal will travel to communicate between the Router and Thermostat. This is an example of badly positioned items for the following reasons.

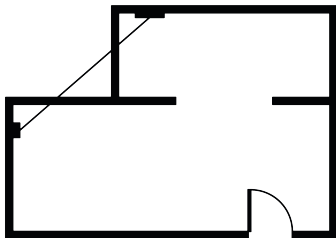

The signal travels between 2 external walls.

GOOD POSITIONING

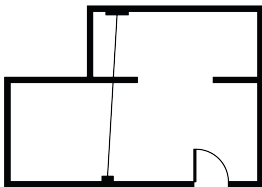

By moving the router we have greatly improved the signal. The signal will now only travel through one internal wall

INSTALLATION

Removal of your old Thermostat (if applicable)

Ensure that your electrical supply is isolated, then remove your old Room Thermostat from the wall. Make a careful note of all wiring locations of the existing Thermostat before removing any wires. Note that the colour codes are not standard.

These should be

- Live or L
- Switch, Switched Live (or Ls, Lr)
- Neutral or N
- Earth or E (optional)

Preparing your new Thermostat

There is a back panel that can be used to fully cover single gang back boxes.

If this is not required, it can be removed from the wallmount by twisting it anti-clockwise. (Fig 1)

Pull the thermostat away from the wall mount. (Fig 2)

Finally, remove the Wiring cover from the wall mount by undoing the screw and pulling this away. (Fig 3)

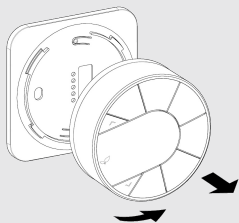

Fig 1

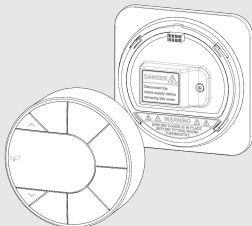

Fig 2

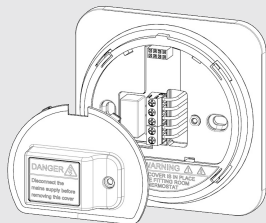

Fig 3

Installing the Wall Mount

For reliable operation, the Thermostat must mount correctly on the wall mount.

If you have a single gang back box, secure the wall mount to this using the two M3 screws provided.

If you do not have an existing back box then, using the wall mount as a template, mark the location of the two holes on the wall. For reference, the two holes are 60.3 mm apart. Drill suitable holes (5mm diameter for the supplied wall plugs) and fix the wall mount to the wall using appropriate wall plugs and screws. **WARNING** be aware of any buried cables before drilling.

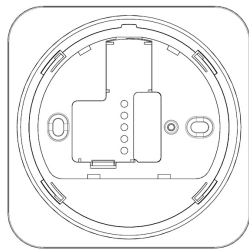

Fig 4

We would recommend using our supplied screws where possible. If not, ensure the screw heads do not protrude above the surrounding wall mount plastic.

This unit is designed for fixed wiring only. Wire the unit up following the appropriate circuit schematic for your heating system type, ensuring that all wires are securely held and that no bare copper is visible outside the connector block. For ease of wiring, we recommend 1mm² cable. All wiring should conform to the current IEEE wiring regulations. When replacing an existing Thermostat, the wiring conversion table, on page 8, may be of assistance.

All diagrams are in schematic form and earths have been omitted on the drawings for clarity. This is a class 2 device and does not require an earth. Ensure that you do not break earth continuity to the rest of the circuit. You may need to join the existing earth leads together using a terminal strip. Ensure that the circuit is protected by a 3 amp fuse.

For guidance please refer to the wiring diagrams below, and/or the Wiring Conversions.

After the wiring has been completed, push the wiring cover into place and secure using the screw provided. (Fig 10)

Place the Thermostat over the wall mount, this will click into place (Fig 11) then secure the Thermostat to the wall mount using the three small pozi screws provided (if applicable).

WIRING DIAGRAMS

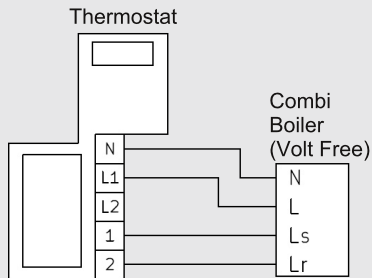

Fig 5: Combi Boiler (Volt Free)

If the combi boiler is new / did not have a Thermostat previously, there will most likely be a wire link that needs to be removed before wiring in the Thermostat.

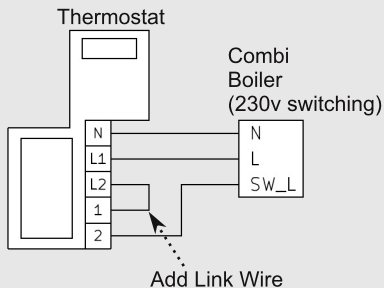

Fig 6: Combi Boiler (230v)

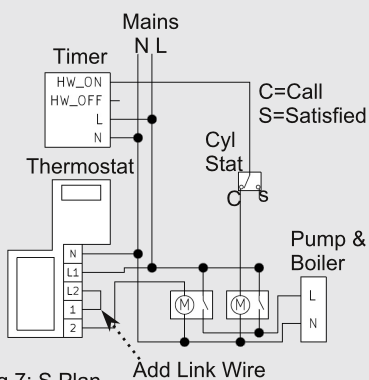

Fig 7: S Plan

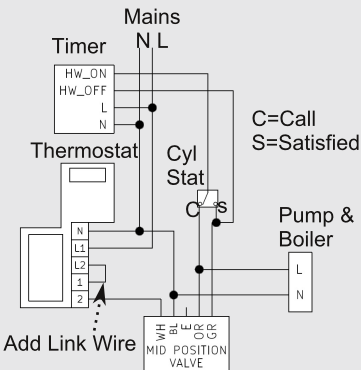

Fig 8: Y Plan

WIRING CONVERSIONS

Ignite	N	L1	L2	1	2
Danfoss RET 230/230F	N	L	Link	Link	3
Danfoss TP1	N	L	Link	Link	1
Danfoss RTC, RTM, RSR, R504	N	3	Link	Link	1
Drayton RTS 1, 2, 3	2	1	Link	Link	3
Drayton RTS 4, 5, 9, 10	N	L		1	3
Horstmann HRT4-A, HFT4, HTT4	2	1	Link	Link	4
Horstmann HRT2, HRT3	4	1	Link	Link	3
Honeywell T6360B, 6060, 6061, 6063	2	1	Link	Link	3
Potterton PRT1, PRT2, 100 ST, 100 DT	N	T/TL	Link	Link	H

more wiring conversions can be found at
www.inspirehomeautomation.co.uk/wiring.html

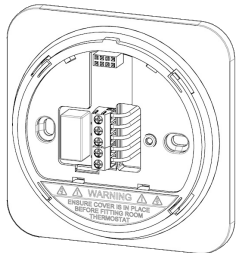

Fig 9

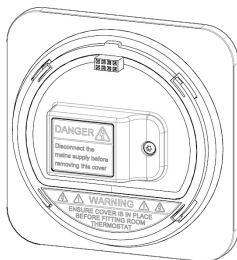

Fig 10

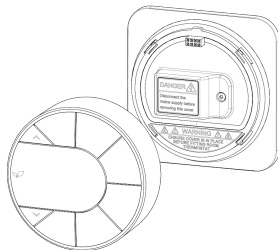

Fig 11

TESTING THE SYSTEM

If the central heating times were controlled by a programmer or timer (external or integrated into the boiler) and these are still wired into the system, these must be left switched to On or Continuous.

The room containing the Thermostat must not have a Thermostat Radiator Valve (TRV) fitted to the radiator(s). If this is the case, this must be removed.

Restore power to the circuit, the Thermostat screen should be illuminated.

Press the 'CH MODE' key until the CH Selector hovers over Man.

Press the '\/' key until the temperature is above the room temperature.

You should see a flame icon appear and hear the relay click within the unit. Check that the boiler has fired up and any zone valves have moved to their appropriate positions.

Press the 'CH MODE' key again. You should hear the relay click off, the flame icon will go out and boiler should no longer be on (please allow a few minutes for the boiler to switch off).

If this does not work as expected, please see troubleshooting on page 12.

ONLINE SETUP WIZARD

Follow our simple, 3 step, online setup and you will be up and running in no time. To start, please browse to:

www.inspirehomeautomation.co.uk/start

***** You will need to be in the same location as the inspire system to complete the initial setup *****

YOUR THERMOSTAT

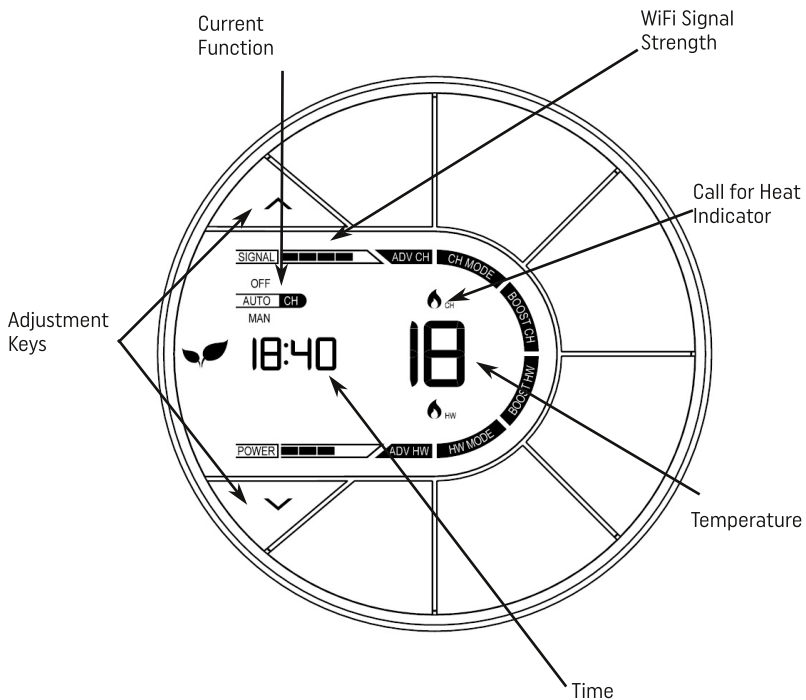

Fig 12

BASIC FUNCTIONS

Off

Your heating will be switched off.

Auto

Your heating will follow your Temperature Profile

The default is: (This can be adjusted via your online account)

15 Degrees between 00:00 and 06:00

20 Degrees between 06:00 and 08.30

17 Degrees between 08:30 and 17:00

22 Degrees between 17:00 and 22:30

15 Degrees between 22:30 and 00:00

Man

Your heating will be switched on and keep your property at the set temperature.

Boost

This is used if you would like to switch your heating on for a set period of time.

The default is 1 hour at 20 degrees. When pressed, 'BOOST CH' will flash to indicate that boost is currently active.

Your heating will switch on for the programmed length of time, at the programmed Boost Temperature (If set.) After this time has expired, the Thermostat will return to the previous state.

Adjusting the Temperature (not applicable when in Off)

Use the '^' and 'v' buttons to set the desired room temperature.

Pressing the 'CH MODE' key will cycle through the following modes:

Program Advance

This is used if you would like to 'jump' to the next profile temperature. Press the 'ADV CH' key to 'jump' to the next Temperature in your schedule. It will only have an effect if the Thermostat is in auto mode. Pressing the 'ADV CH' key a 2nd time will cancel the program advance and the unit will revert back to the current profile set temperature.

Setting the Clock

If you have an Internet connection, this will be done automatically. If you are outside of the United Kingdom, you can specify your time zone on the 'Setup' page within your online account. To set the clock manually, press the 'BOOST CH' and 'BOOST HW' keys to enter the menu. Use the '+' and '-' keys to set the hours, then press 'ADV CH' this will take you to the minutes and then the days (1 = Sunday, 7 = Saturday) which are set in a similar way. To exit the menu press the 'BOOST CH' and 'BOOST HW' keys simultaneously.

SETTING UP YOUR ACCOUNT

Please check what version you have on the below list and follow the weblink for more information.

Residential – www.inspirehomeautomation.co.uk/residential

Landlord – www.inspirehomeautomation.co.uk/landlord

Calendar – www.inspirehomeautomation.co.uk/calendar

PHONE APP

Please go to this weblink to download the app www.inspirehomeautomation.co.uk/apps

TROUBLESHOOTING

Please visit our website for more information on trouble shooting:
www.inspirehomeautomation.co.uk/help

Please check out our **fault finding guide** and **FAQ** for assistance, there will also be information here on how to contact us.

Please leave this manual with the user.